

OXIPAN[®]L

Drinking Water

IK-765 Series

Oxidizer + pH Inline Analyzers for Drinking & Clean Water Startup Guide



Pyxis Lab Inc.
October 2021

Product Description

The IK-765 series are dual-parameter inline water analyzers specifically designed as a 'Turn-Key' monitoring solution for clean water applications including drinking water networks, secondary water supply and decorative/swimming water applications. The IK-765 series offers highly accurate, real-time measurement, display and data-logging of Oxidizer, pH and Temperature utilizing proprietary Pyxis Lab smart sensor technology, coupled with a Pyxis UC-50 micro display and data logging terminal. The IK-765 series is offered in a convenient and easy to integrate panel mounted format for rapid installation and simple maintenance.

The IK-765 series analyzer is offered in three sensor formats depending on the desired oxidant being measured. The panel design is equipped with the propriety Pyxis ST-765SS Series smart sensors based on application needs. The ST-765SS series sensors measure Free Chlorine or Chlorine Dioxide, pH and temperature of the sample water. This Pyxis sensor design is membrane-free and based on unique principles and incorporates Pyxis' advanced technology in the field of bare-gold electrochemical detection. The ST-765SS-FCL (Free Chlorine + pH) and ST-765SS-CLO (Chlorine Dioxide + pH) sensors measure the oxidant level and pH simultaneously while performing temperature and pH compensation for the measurement of oxidant based on conditions present in the application of use. Each IK-765 panel is also provided with the FR-50 Flow Reservoir and UC-50 micro display/data logging terminal prewired to the ST-765SS series sensor of in RS-485 modbus format with fully integrated sensor diagnostics and calibration interface.

This unique platform with internal sensor compensation results in a highly accurate oxidizer measurement consistent with DPD wet chemistry methodology as high as pH 9.0+ and meets EPA-334.0 and ISO-7393 compliance.

Turn-Key Installation

The IK-765 series analyzer requires a small installation footprint, offers simple operation and maintenance and is specifically designed for use in domestic and drinking water applications. The analyzer may also be integrated with the optional Pyxis PowerCloud™ 4G remote gateway, which can upload on-site analyzer data to a cloud server in real time and allow for additional sensor/device inputs for cloud access. Contact Pyxis Lab for details on PowerCloud™ and Pyxis Cloud™.

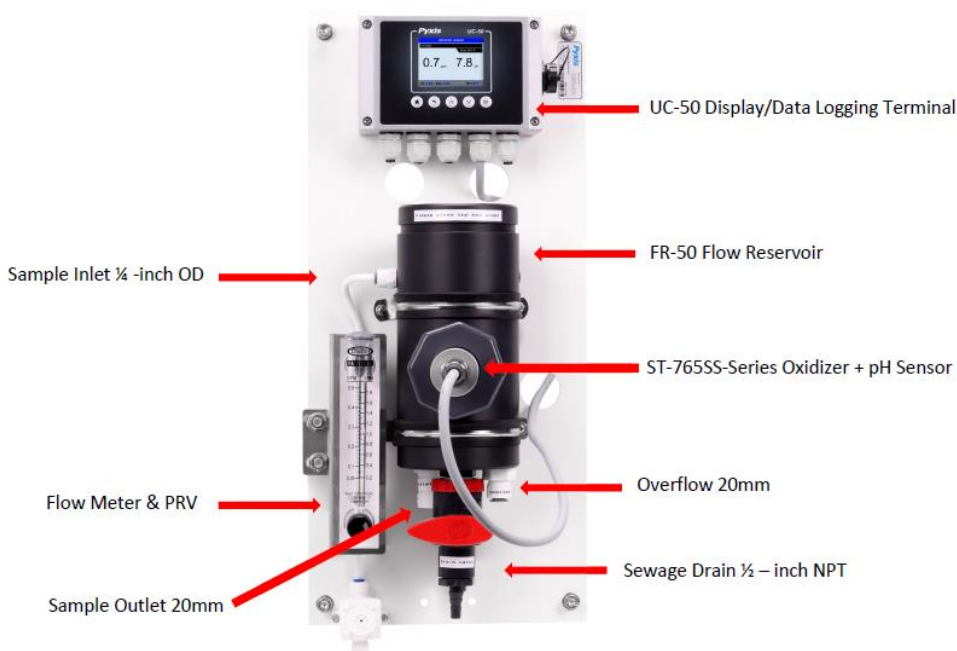

Typical Applications

- Drinking Water / Domestic Water / Secondary Water Supply
- Sanitary Water
- Decorative Water
- Food & Beverage Process Water
- RO Feedwater



Features

- Pyxis Lab's advanced research and development sensor technologies to achieve highly accurate and stable measurement of Free Chlorine, Total Chlorine or Chlorine Dioxide, pH and Temperature.
- Pyxis ST-765SS-FCL (Free Chlorine + pH/Temperature) and ST-765SS-CLO (Chlorine Dioxide + pH/Temperature) are three-parameter composite sensors used for the measurement residual free chlorine or chlorine dioxide, pH and temperature in compliance with USEPA 334.0 and ISO-7393 guidelines. The sensors advanced PCB offers built-in temperature and pH parameter compensation (up to pH 9.0+) algorithms eliminating the need for a supplemental pH sensor and controller. Unique Bare-Gold electrode technology for residual chlorine measurement eliminates membranes and electrode solution replenishment commonly associated with conventional sensors. The ST-765SS Series has a uniquely designed flat bubble pH electrode design for reduced fouling potential. Reduce your maintenance and cost versus colorimetric chlorine measurement or conventional electrochemical sensors by utilizing Pyxis replaceable Electrode Head (EH-765) for this sensor allowing for years of reliable service. The ST-765SS Series may be calibrated in-situ after cleaning via DPD Free Chlorine or Chlorine Dioxide wet chemistry test measurement of active sample.
- Pyxis FR-50 Single-Sensor flow reservoir provides sample calming for dissipation of air-bubbles and settling of suspended solids, foam or other impurities commonly observed in drinking water influent. This unique flow reservoir design results in the highest level of oxidizer resolution on the market and greatly extends the maintenance cycle of the sensor while providing a large buffer capacity to mitigate pressure fluctuations. The minimum inlet pressure of FR-50 flow reservoir is only 7.5 psi (0.05mpa) making it highly suitable for the end of pipe networks and secondary supply influent sampling. One FR-50 is provided with the purchase of each ST-765SS Series sensor and comes equipped with inlet PRV and Rotameter for the recommended flow range of 600-1,800 mL/minute. The FR-50 outlet flow and sewer overflow lines should be diverted to drain or the inlet of the pretreatment system for those desiring NSF compliance.
- Simple sensor removal and replacement. The ST-765SS Series sensors are connected to the display/data logger via RS-485 modbus (RTU) allowing for integrated sensor calibration interface and diagnostics within the display screen.
- Convenient and simple to install Back-Panel (IK-765) for rapid and easy installation. Truly a plumb and power to go platform with intense factory setup, testing and sensor calibration prior to shipment.
- UC-50 micro display/data logger interface with sensor calibration integrated. Display/data logger offers 1x 4-20mA I/O as well as RS-485 with remote diagnosis and parameter adjustment. Pyxis PowerCloud™ 4G Gateway available as an optional accessory.

Specifications

Item	IK-765SS-FCL	IK-765SS-CLO
P/N	42082	42085
Sensor Body Material	304SS	
Sensor Name	ST-765SS-FCL	ST-765SS-CLO
Oxidizer Range	0.00-5.00 ppm Oxidizer (auto-range)	
Oxidizer Precision	± 0.01mg/L or 1% of the value w/pH compensation up to 9.0+	
pH Range	0-14	
pH Precision	± 0.01 pH	
Sample Operating Temperature	4 °C – 40 °C (40 – 104 °F)	
Sample Inlet Pressure	7.25 – 30 psi (0.05 – 0.2MPa)	
Sensor Maximum Pressure	100 psi (6.9 Bar)	
Sensor Response Time	T95≤60s – Oxidizer / T95≤5s - pH	
Measurement Interval	Continuous	
Installation	FR-50 Self-Regulating Flow Reservoir w/Rotameter & PRV - Included	
FR-50 Minimum Flow Rate	600 mL/minute	
FR-50 Maximum Flow Rate	1,800 mL/minute	
FR-50 Sample Inlet	1/4 - inch OD	
FR-50 Sample Outlet	20 mm - To Drain	
FR-50 Overflow Outlet	20mm - To Drain	
FR-50 Sewage Drain	½ -inch NPT	
Panel Power Supply	110/220VAC 50/60 Hz, 0.6A	
Panel Storage Temperature	-4 – 158 °F (-20 – 70 °C)	
Panel Operating Temperature	32 – 122 °F (-0 – 50 °C)	
UC-50 Display	2.8" Color 320 x 240 Resolution	
Input	1 x 4-20 mA / RS-485 Modbus-RTU	
Output	1 x 4-20 mA / RS-485 Modbus-RTU / 1 x Contact Relay	
Data Storage	32 M Flash	
USB	1 x USB host for data downloading	
Relative Humidity	5% - 95% (No Condensation)	
Altitude	<6,561 feet (<2,000 Meter)	
Dimension (H x W x D)	Panel (IK-765SS) 590H x 250W x 330D mm	
Approximate Weight	Panel (IK-765SS) ~ 5 kg	
Wet Material	UPVC / Polycarbonate	
Rating	IP-65 Panel-Display / IP-67 Sensors	
Selectivity	Non-Selective / cross sensitive to other oxidizing species	
Compliance	EPA 334.0 / ISO 7393	
Regulation	CE Marked / RoHS	
Typical Electrode Service Life	2 years	
Electrode Warranty	6 Months	
Sensor Body Warranty	13 Months	

**NOTE* - Pyxis Lab is consistently updating technologies, as such, specifications may change without notice.
 Technical specifications on the ST-765SS Series sensors can also be found in their respective Operation Manuals.
 Contact info@pyxis-lab.com for details or www.pyxis-lab.com.*

IK-765SS Series Panel Dimensions (mm)

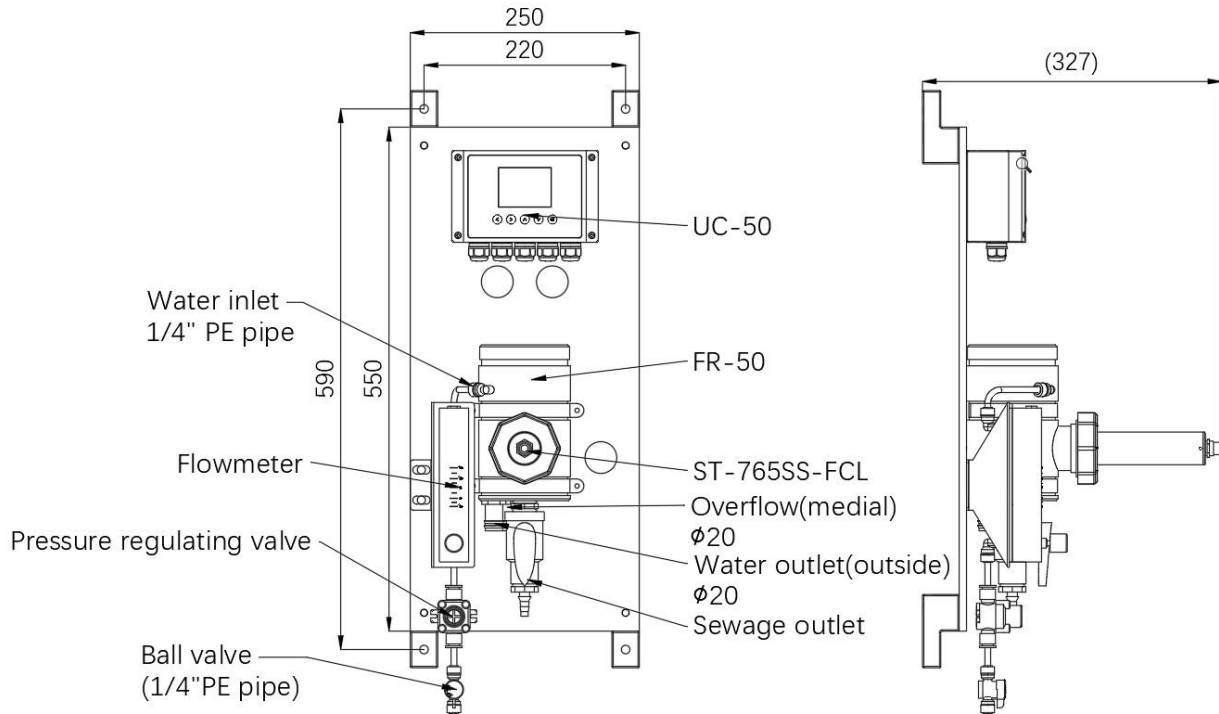

IK-765SS Series UC-50 Display/Data Logger Dimensions (mm)

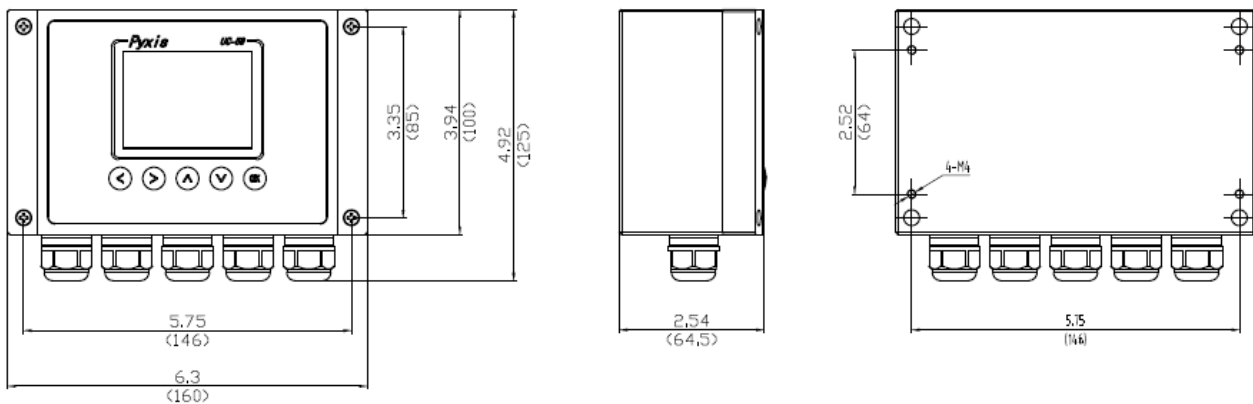

IK-765SS Series FR-50 – Flow Reservoir Dimensions (mm)

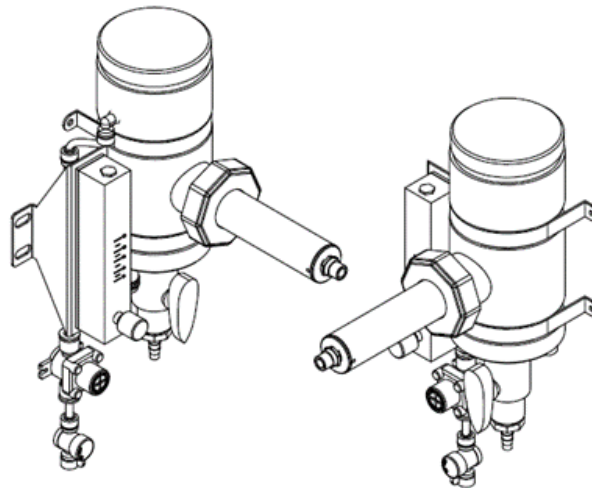
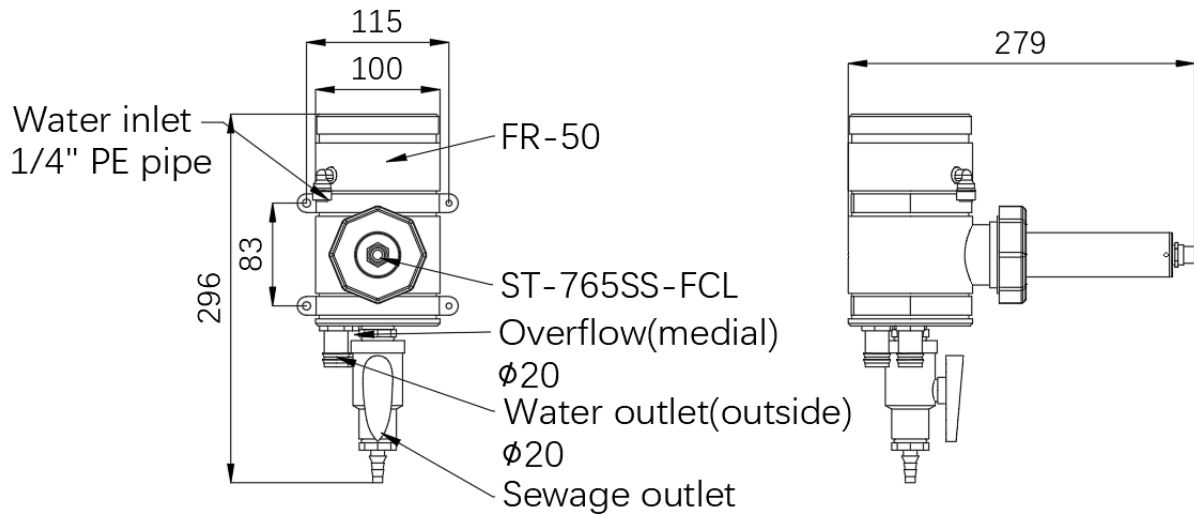

ST-765SS Series Sensor Dimensions (mm)

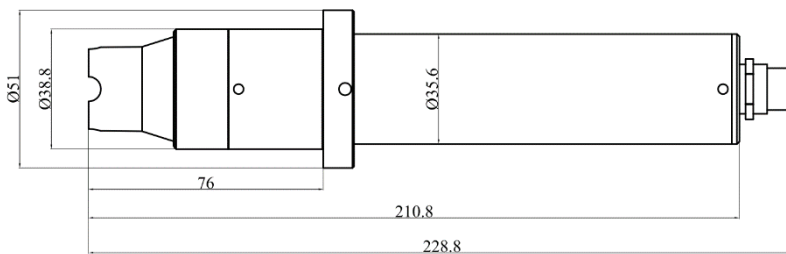

ST-765SS-Series Oxidizer + pH Sensor

IK-765 SERIES AND ACCESSORIES ORDER INFORMATION

Order InformationIK-765SS-FCL (*Free Chlorine + pH + Temperature Analyzer*)**P/N**

42082

IK-765SS-CLO (*Chlorine Dioxide + pH + Temperature Analyzer*)

42085

Optional / Replacement Accessories Information**P/N**ST-765SS-FCL (*Free Chlorine + pH + Temperature Sensor w/Internal Compensation-Sensor Only*)

53607-NFR

ST-765SS-CLO (*Chlorine Dioxide + pH + Temperature Sensor w/Internal Compensation-Sensor Only*)

53608-NFR

EH-765 (*Replacement Electrode Head for ST-765SS-Series Sensors*)

53061

FR-50 (*Replacement FR-50 Flow Reservoir w/Rotameter & PRV*)

50700-A01

UC-50 Display + Data Logging Terminal (*Replacement*)

43007

SP-200 OxiPocket™ (*Pocket All-Oxidizing Disinfectants Colorimeter & Fluorometer*)

50802

Pyxis pH Calibration Combo Pack (*4-7-10 Calibration Solution 3-Pack-500mL each*)

57007

Zero Oxidizer Calibration Standard Solution (*500mL Bottle*)

20022

ST-SERIES PROBE CLEANING KIT

SER-01

UC-50 TERMINAL BOARD WIRING DIAGRAM

Please refer to the wiring terminal diagram below for the UC-50 display/data logger. **NOTE** – the UC-50 terminal board provides two prewired 8-pin pigtail cables with adapters. The input cable offers a male adapter for direct connection to the ST-765SS Series sensor input. This cable is to be terminated to the sensor only.

The output pigtail offers a female adapter. This pigtail cable is designed to be connected to the loose flying lead cable with male adapter and open wires that is provided with the panel. This 8-pin output enables 2x 4-20mA signal passthrough and 1x RS-485 passthrough of the ST-765 Series sensor as well as one 4-20mA USER-DEFINED output from the UC-50 and 1x 24-VDC (10Watt) Relay output to pass onto another device. Output wiring details can be found in the next section of this manual

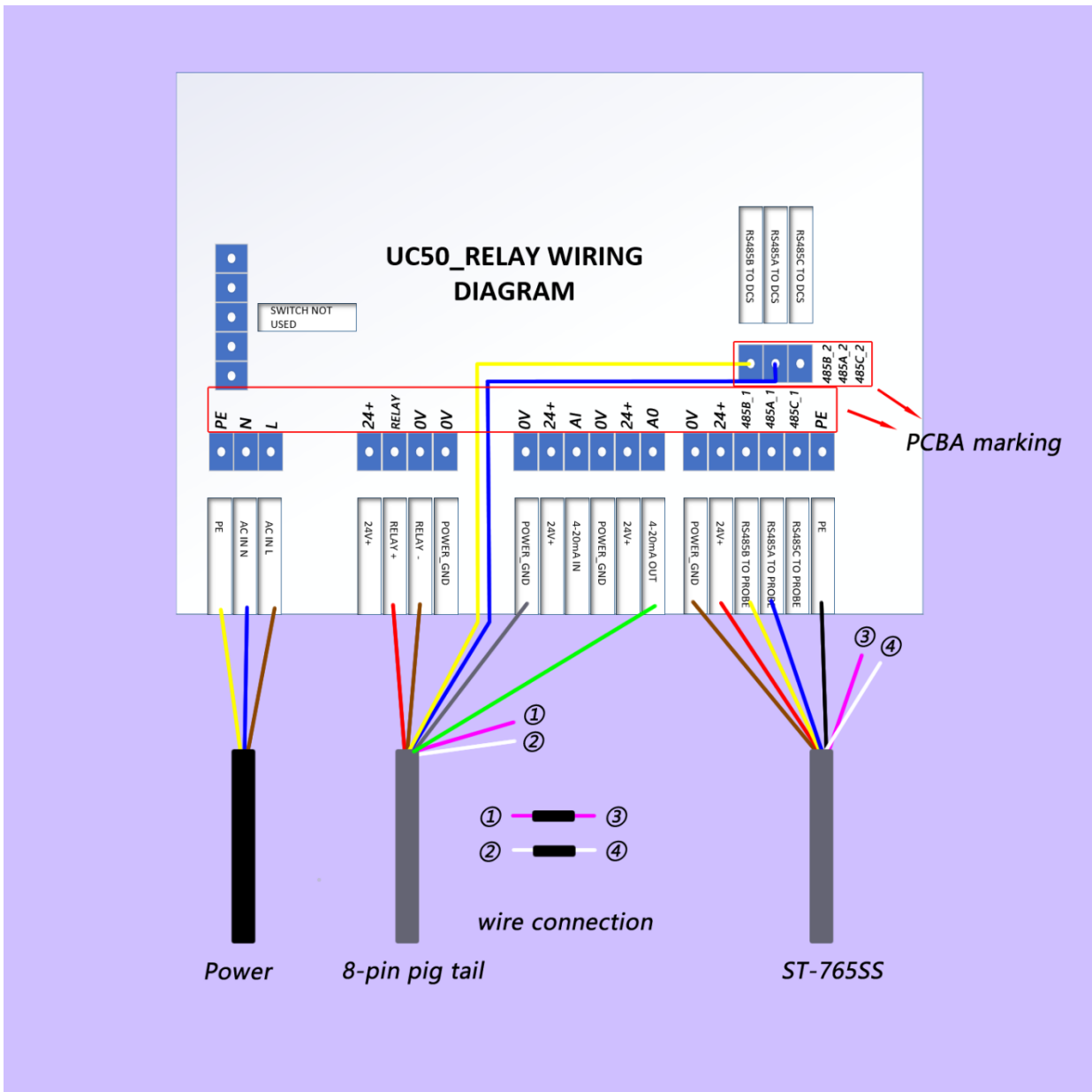

UC-50 OUTPUT SIGNAL/RELAY WIRING DETAILS AND 4-20mA RANGES

As mentioned in the previous section, the UC-50 internal terminal board is prewired with two 8-pin cable pigtail cables. The input cable (male adapter) is to be terminated the ST-765SS series sensor. The output cable (female adapter) is to be terminated to the loose flying lead cable provided with the panel and allows 2x 4-20mA output signals and 1x RS-485 signal of the ST-765SS Series sensor to be PASSED-THROUGH to another receiving device in addition to 1x 4-20mA USER DEFINED output from the UC-50 (referred to as AOut in UC-50 dropdown list). Additionally, the prewired 8-pin output cable offers a 24VDC (10Watt) relay for operation of alarm, light, buzzer or other device based on the user relay settings in the UC-50 itself.

The flying lead section of the loose shipped output cable may then be landed to the input terminal of "ANOTHER DEVICE". This passthrough of the 2x 4-20mA signals and 1x RS-485 signal directly from the ST765 series sensor (pH + Oxidant), as well as the 1x user defined UC-50 4-20mA output and 1x 24VDC Relay for use as desired. Please refer to the wiring table below for proper wiring of 8-pin output cable provided with each UC-50.

Output Wire-Color	Designation
Red	Relay+
Brown	Relay-
Blue	485A
Yellow	485B
Pink	4-20mA+ for pH
Gray	4-20mA-
White	4-20mA+ for Oxidizer
Green	4-20mA+ from UC-50 User Assigned <i>(Available with Serial #220018 and after)</i>

ST-765SS Series Sensor Signal Pass-Through From UC-50		
Unit of Measure	4mA Value	20mA Value
pH	0.00 pH	14.00 pH
Oxidant (FCL/CLO2)	0.00 ppm	5.00 ppm
UC-50 Analog Output	User Defined	User Defined





8-Pin Output Flying Lead Cable
Provided for Sensor Signal
Passthrough and Relay Output

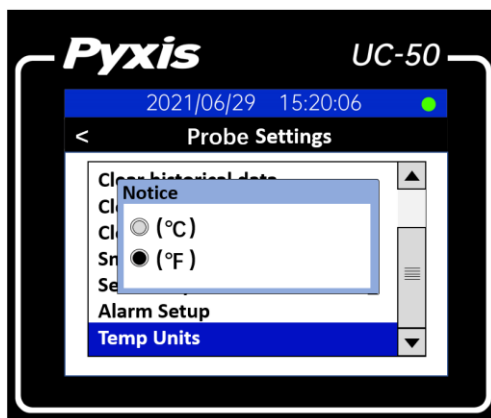

TEMPERATURE UNIT of MEASURE SETUP PROCEDURE

The display unit of temperature is Celsius by default. Users can switch the temperature unit as desired in **Temp Units** notification box. From the **Main Menu**, select **Temp Units**. Here you may alter between desired unit of measure for the analog output scale.



Return to the **Home** page by pressing . On the Home page the temperature reading will be displayed in the upper right corner of the screen in the units of measure selected.

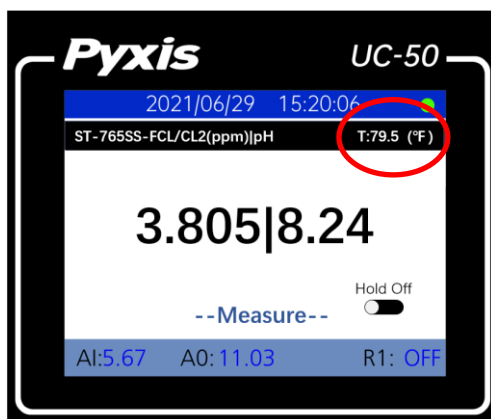

UC-50 SETUP OF USER DEFINED ANALOG OUTPUT FEATURE

UC-50 display/data logger supports one extra 4-20mA output of any sensor measurement parameter to be user defined for units with serial # 220018 and after. This will be programmed for Temperature as a default from the Pyxis factory and is referred to in the previous section this output is internally connected to the Green wire of 8-pin output pigtail table. Users can select the **AOut** setting interface of the UC-50 then click on the **Parameter** option to select the ST-765SS Series probe measurement parameters and alter the A-Out as desired.

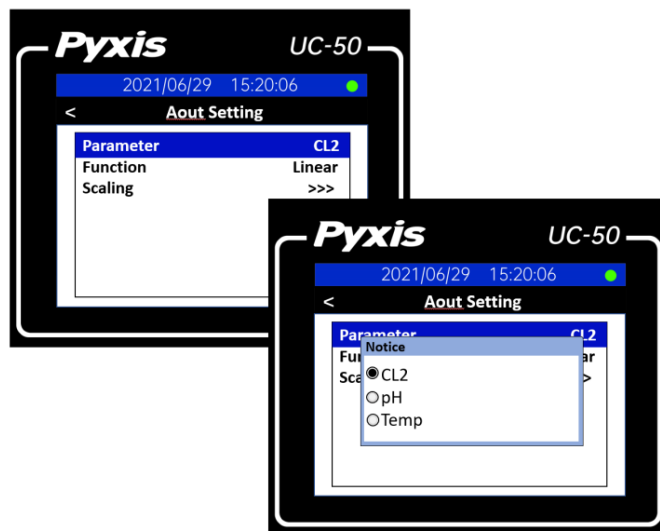

Click **Scaling** option to enter the 4-20mA span interface. You can change the Oxidizer, pH or Temperature value corresponding to the 20mA output to the same or lower default value as seen in the figure below. Click the **OK** button when complete.

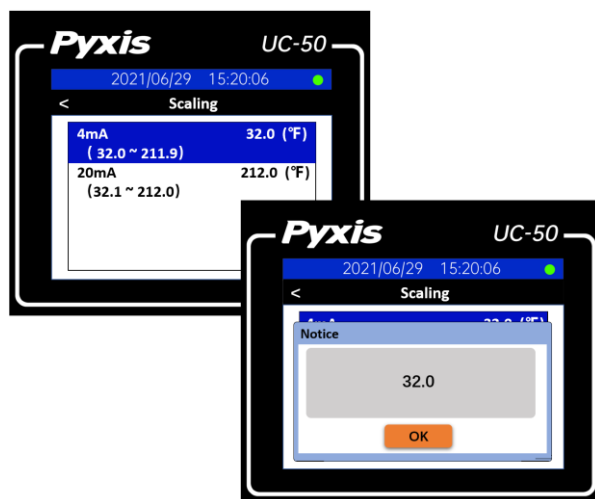

UC-50 Analog Output 4-20mA Range of Measurement		
Unit of Measure	4mA Value	20mA Value
pH	0.00 pH	14.00 pH
Oxidant (FCL/CLO2)	0.00 ppm	5.00 ppm
Temperature (°C / °F)	0.0 °C / 32.0 °F	100.0 °C / 212.0 °F

UC-50 RELAY CONFIGURATION

The UC-50 is equipped with relay output (24V, 8w) which is designed for alarm relay activation or may be used as desired. The UC-50 relay offers 5 modes of operation. The number of adjustable parameters will differ depending on the mode the user selects.

1. DISABLE RELAY MODE

When setting [**Disable**] mode, the relay does not accept any functions or allow any actions.

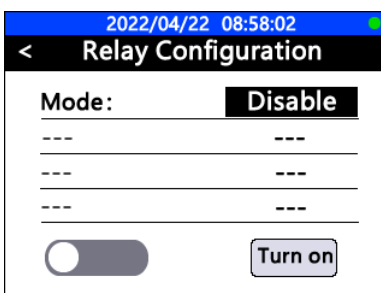

2. MANUAL RELAY MODE

When setting [**Manual**] mode, you need to press ▼ to move the cursor to the button, then press **OK** to turn on the relay manually. You will note the “Turn OFF” button activated at bottom of page when in Manual Mode with a GREEN COLOR coded button to left indicating the relay is currently ON. When pressing the “Turn OFF” button, you will deactivate relay. Press again to activate.

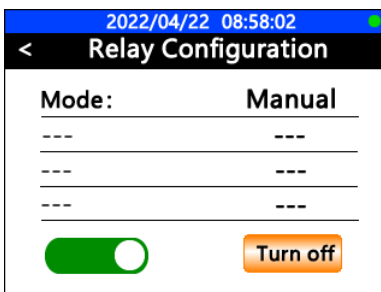

3. TIME RELAY MODE

When setting [**Time**] mode, the relay will repeat the activation metering according to the timing period (hr) and hold time (min) programmed by the user. EXAMPLE - The Parameters displayed below represent the relay turning on every 24 hours, for a duration of 60 minutes.

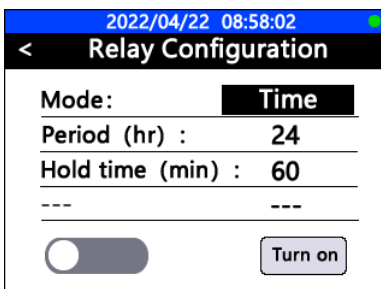

4. ALARM (LL) or ALARM (HL) MODES

The **Turn ON** and **Turn OFF threshold** values are constantly compared with the primary measurement of the sensor. In the case of OxiPanel, the primary measurement is oxidizer (ie. Free Chlorine)

Security time is used to set the activation time of the relay in a range of 0 ~ 99999 seconds. If user does not want to limit the activation time of the relay, the **security time** should be set to “ 0 ”.

- In **Alarm LL** (Alarm Low Limit) mode, once the measurement value falls below the **Turn ON threshold value**, the UC-50 will turn the relay on. Once the measurement value exceeds the **Turn OFF threshold**, the UC-50 will turn the relay off.
- In **Alarm HL** (Alarm High Limit) mode, once the measurement value exceeds the **Turn ON threshold value**, the UC-50 will turn the relay on. Once the measurement value falls below the **Turn OFF threshold**, the UC-50 will turn the relay off.

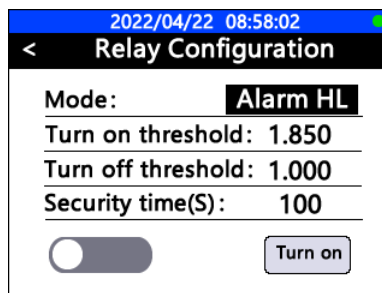
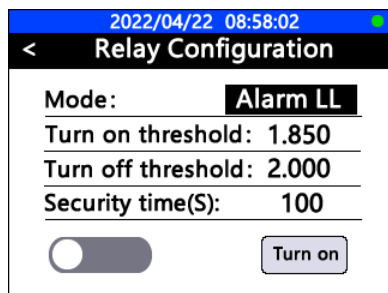

NOTE - If the user program security time has been reached but the alarm Lower limit or alarm higher limit have not been met, the UC-50 main screen measurement values will turn **RED**.



UC-50 MODBUS RTU SLAVE STATION COMMUNICATION PARAMETERS

UC-50 Default Communication Parameters	
Device Address	20
Baud Rate	9600
Word Length	8
Parity	None
Stop Bits	1

UC-50 Default Communication Parameters – (Writeable)			
Register Address	Type	Byte Order	Register Definition
42001	Unsigned int 16	AB	Device Address
42003	Unsigned int 16	AB	Parity 0=None Parity 1=Odd Parity 2=Even
42004-42005	Unsigned int 16	CDAB	Baud Rate

UC-50 Register Address of Measured Parameters – (Read-Only)			
Register address	Type	Byte order	Register definition
46001-46002	float	CDAB	Oxidizer
46003-46004	float	CDAB	pH
46005-46006	float	CDAB	Temperature
46007-46008	float	CDAB	4-20mA input

NOTE If the base address is 1, such as PLC system, access directly according to the register address. If the base address is 0 system, the register address is reduced by 1 after access.

START-UP PROCEDURE



Main key Up key OK key
 Back key Down key

- Main key**-Return to the main screen from any interface
- Back key**-Return to the last displayed screen
- Up key**-Select different settings or adjust parameters
- Down key**-Select different settings or adjust parameters
- OK key**-Confirm to enter a setting page or confirm parameters

The UC-50 display of the IK-765 panel is connected via RS-485 Modbus (RTU) to the ST-765SS Series probe when it leaves the Pyxis factory. After the UC-50 is turned on, the main interface of the UC-50 will display the **residual chlorine or chlorine dioxide concentration, pH value, and temperature** of the tested solution. The green dot in the upper right corner of the UC-50 main interface indicates that the communication between the UC-50 and ST-765SS probe is normal. If used, the 4-20mA input signal, 4-20mA output signal and relay output status are displayed at the bottom of the UC 50 main interface.

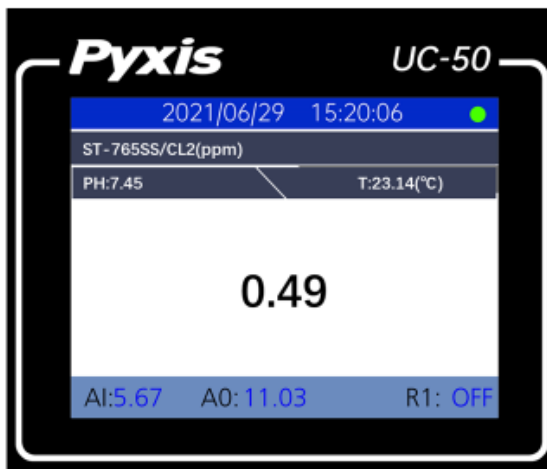

Click the back key on the main interface, UC-50 will display the setting interface. All probe-related settings and UC-50 settings can be selected on this page. If you need to connect a new probe, please select the **Probe Settings** and then click the ok key button to enter the probe setting page

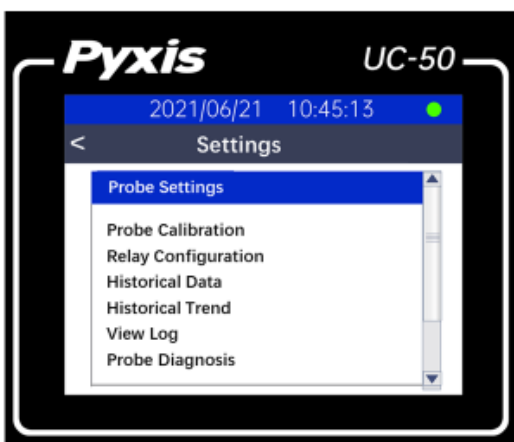

Select the probe setting to enter the desired Pyxis **Probe Type** setting interface. UC-50 controller supports manual selection of the probe type or automatic identification of the probe type. Please use the up/down keys to select the correct probe type or select automatic identification.

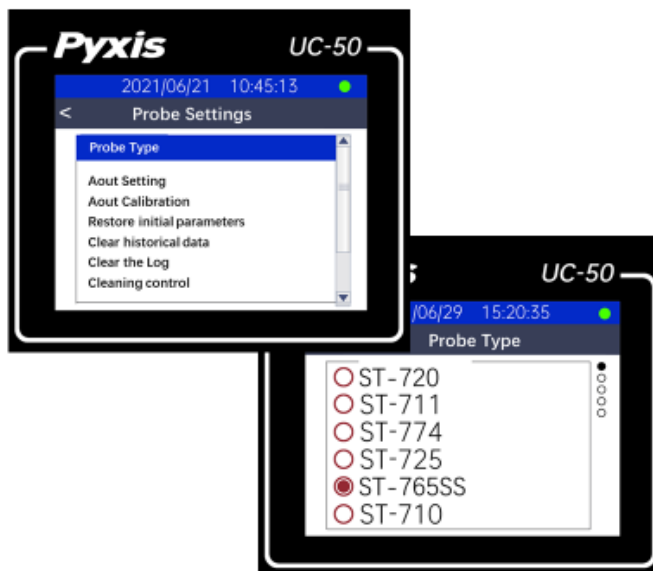

pH LOW - CALIBRATION PROCEDURE

PH-L calibration should be selected on the **Probe Calibration** page. Remove and place the ST-765SS Series probe in the pH 4.0 standard solution, measure for 1 minute and wait for the measurement result to stabilize, click the **OK** button to start the PH-L calibration.

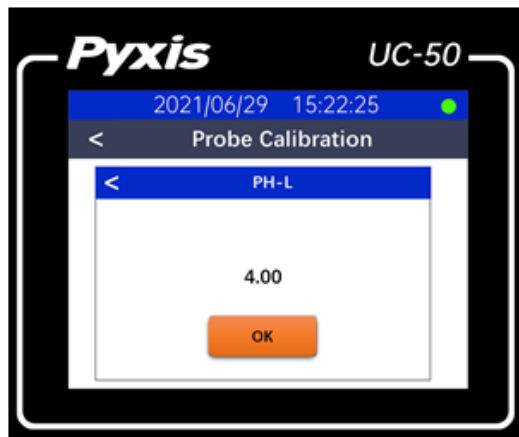

Select the **OK** button on the probe calibration confirmation page. The UC-50 controller sends the **PH-L calibration** command to the ST-765SS probe and waits for the probe calibration result. The probe calibration result will be automatically displayed on the calibration interface.

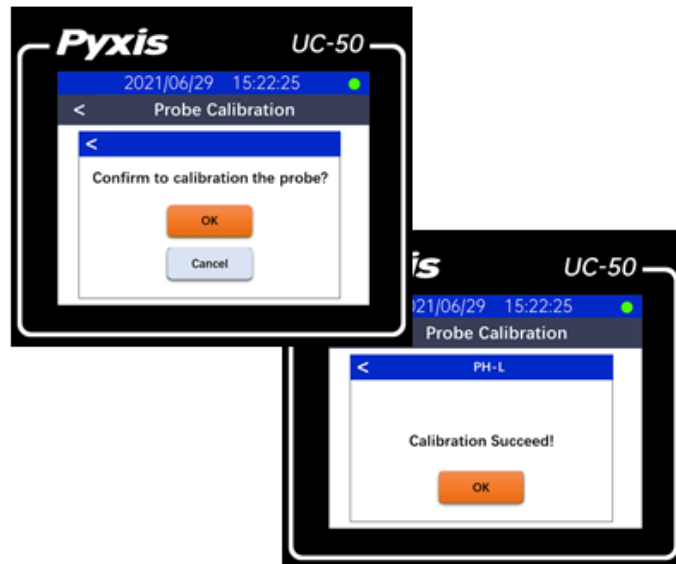

pH MID (Z) - CALIBRATION PROCEDURE

PH-Z (7) calibration should be selected on the **Probe Calibration** page. Place the probe in the pH 7.0 standard solution, measure for 1 minute and wait for the measurement result to stabilize, click the **OK** button to start the PH-Z calibration.

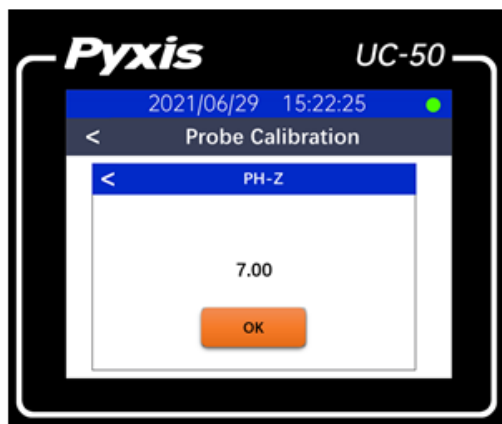

Select the **OK** button on the probe calibration confirmation page. The UC-50 controller sends the **PH-Z calibration** command to the ST-765SS probe and waits for the probe calibration result. The probe calibration result will be automatically displayed on the calibration interface.

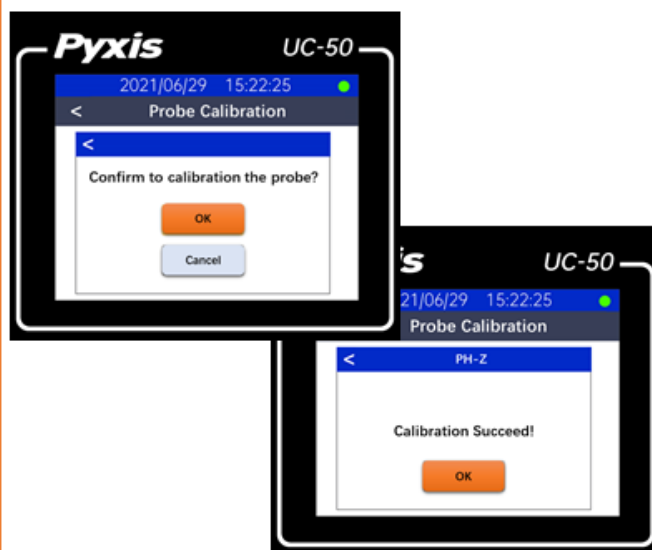

pH HIGH - CALIBRATION PROCEDURE

PH-H calibration should be selected on the **Probe Calibration** page. Place the probe in the pH 10.0 standard solution, measure for 1 minute and wait for the measurement result to stabilize, click the **OK** button to start the PH-H calibration.

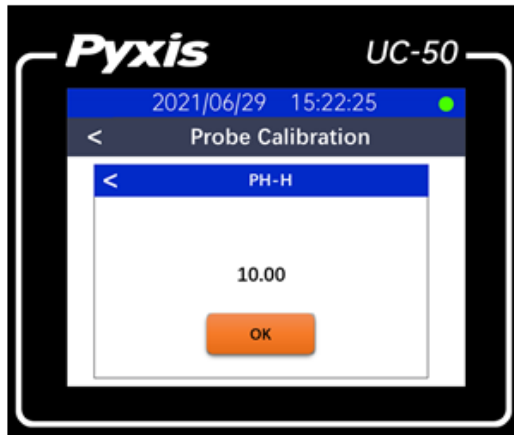

Select the **OK** button on the probe calibration confirmation page. The UC-50 controller sends the **PH-H calibration** command to the ST-765SS probe and waits for the probe calibration result. The probe calibration result will be automatically displayed on the calibration interface.

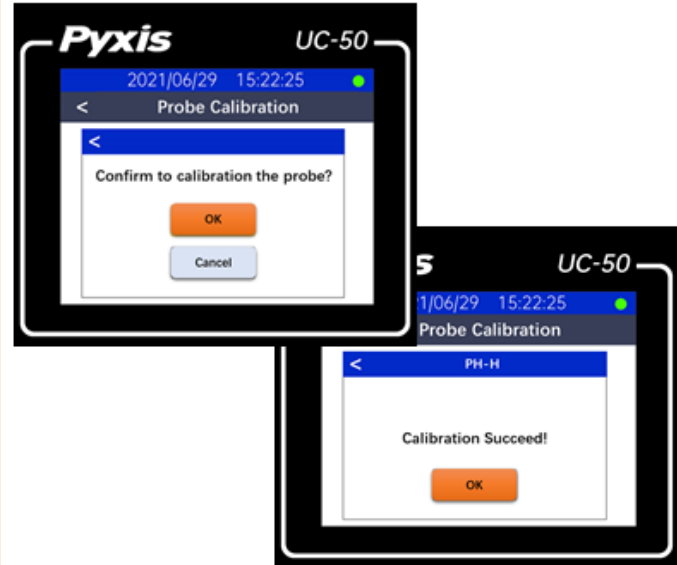

ZERO OXIDIZER - CALIBRATION ROCEDURE

Select the **Probe calibration** in the setting interface to enter the ST-765SS probe calibration interface as shown in the figure below. Use the up and down keys to select 5 calibration types. **Zero calibration** is selected on the **Probe Calibration** page, first put the probe into the zero-oxidizer standard solution (Pyxis P/N 20022) or 100us/cm Conductivity Standard is also acceptable for zero standard solution. After the probe reading is stable for at least 10 minutes, click the OK button to start the zero calibration.

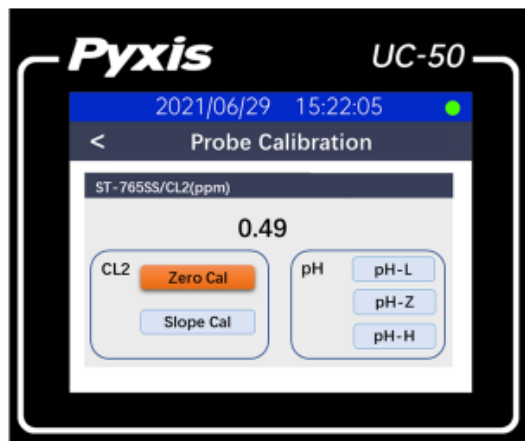

Select the **OK** button on the probe calibration confirmation page. The UC-50 controller sends the **Zero calibration** command to the ST-765SS probe and waits for the probe calibration result. The probe calibration result will be automatically displayed on the calibration interface.

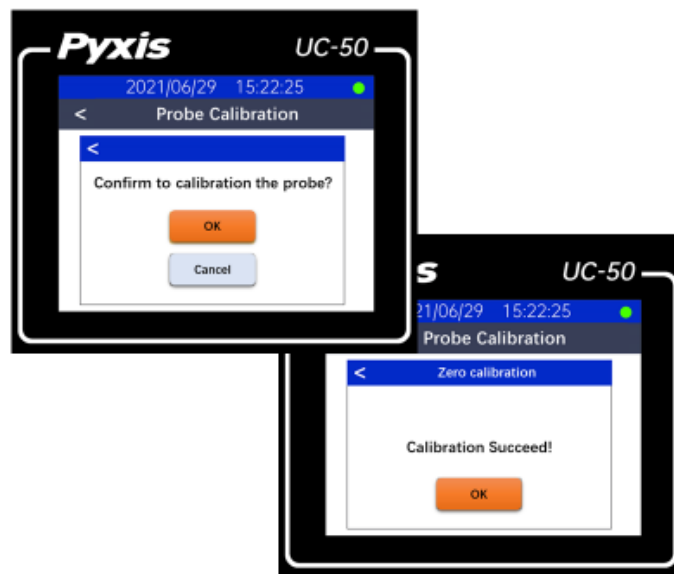

SLOPE OXIDIZER -CALIBRATION ROCEDURE

Slope calibration should be selected on the **Probe Calibration** page. While the sensor is exposed to active flow of 200-400 mL/minute in the FR-50 flow reservoir, enter the free chlorine or chlorine dioxide concentration determined by the DPD method of the sample and ensure that probe reading has been stable for at least 10 minutes before calibration. Click the OK button to start the slope calibration.

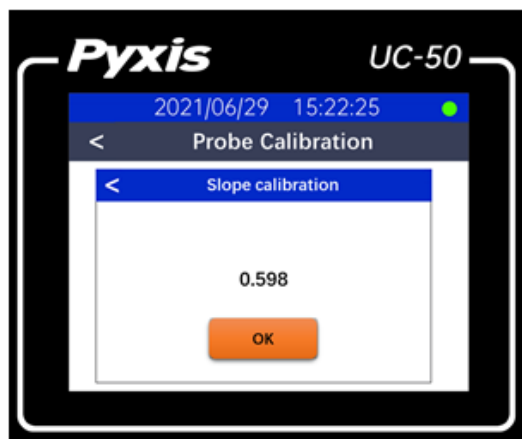

NOTE: The ST-765SS Series must be slope calibrated in the FR-50 flow reservoir provided with the sensor and have consistent flow.

Select the **OK** button on the probe calibration confirmation page. The UC-50 controller sends the **Slope calibration** command to the ST-765SS probe and waits for the probe calibration result. The probe calibration result will be automatically displayed on the calibration interface.

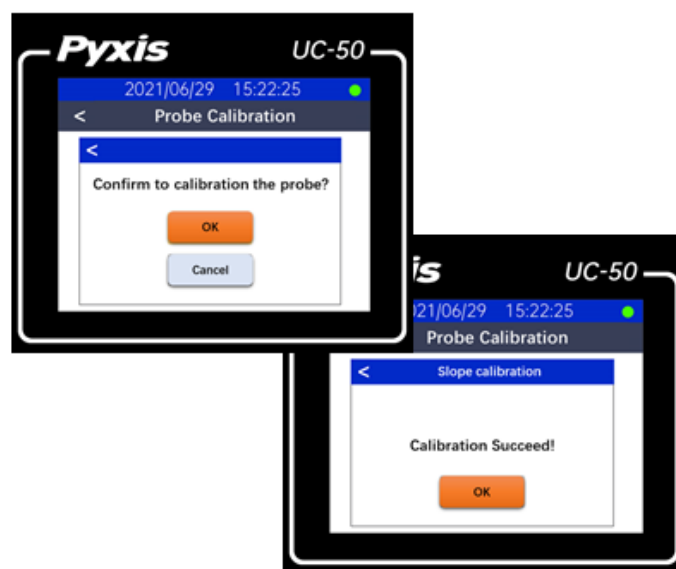

HISTORICAL DATA & TRENDING

Select **Historical Data** on the setting interface of the UC-50 controller. You can view the stored historical measurement data of ST-765SS. UC-50 controller stores measurement data of ST-765SS every 1 minute. This time period may be adjusted if desired. You can browse the data of different time periods with the up and down keys.

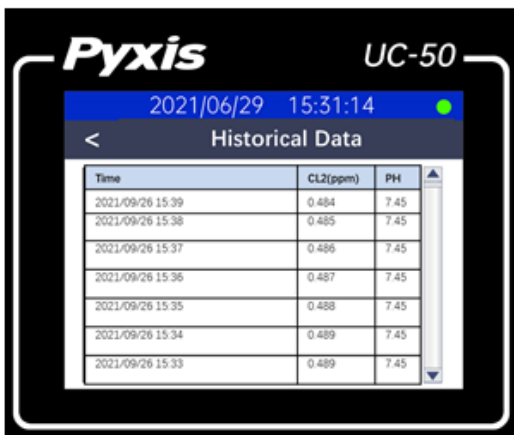

Select the **Historical Trend** on the setting interface of the UC-50 controller. You can view the historical measurement data saved by the UC-50 controller in the form of a trend graph. Use the up and down keys and the confirm key to select to view the data of the last day, week or month.

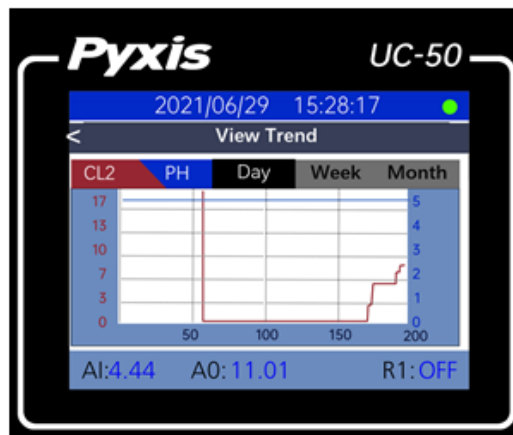

HISTORICAL TREND SCALE SETUP

4FNADUU F **Setup Trend** PO U F I JTUPSIDBMIFOE JCUF30DF UP N PEJGZ U F N BYJN VN BCE N JOIN VN VBMFT PGU F : BYJT PG U F DVSWF-1NMBTF TFUU F BQQSPQSIBUF : BYJT SBOHF BDDPSEJCH UP U F BDJVBMI FBTVSFN FOUTJUVBUPO TP U BUU F I JTUPSIDBM DVSWF DBOCF CFUUFSEJTONZFE-6TF U F VQBOE EPX OLFZT BOE DPCGSN LFZT UP N PEJGZ~



RESTORING FACTORY PARAMETERS & PROBE DIAGNOSIS

If the abnormal reading of the probe is caused by improper calibration, you can select the **Restore initial parameters** function in the probe setting interface of the UC-50 controller to restore the ST-765SS probe to the factory parameters.

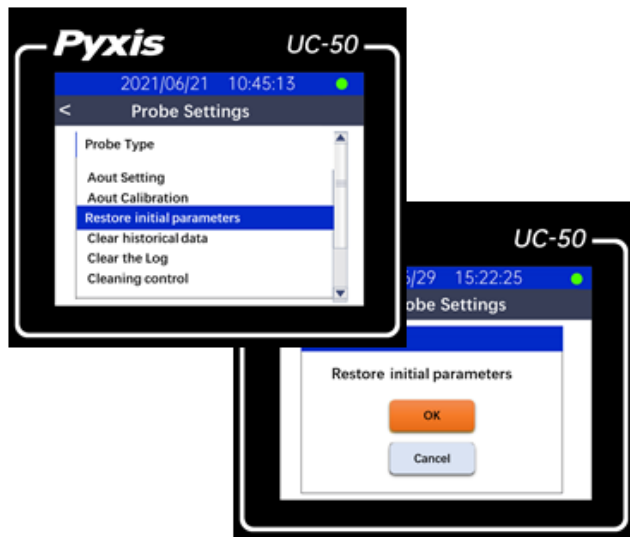

The UC-50 controller supports displaying the original diagnostic data of the ST-765SS. To help troubleshooting possible issues with the probe, please save images of these data when the probe is respectively placed in a clean water (tap water), in a free chlorine/chlorine dioxide or pH standard solutions. Email the images to service@pyxis-lab.com for technical support. Selecting the **Probe Diagnosis** in the setting interface of UC-50 controller will display the internal original diagnosis data interface.

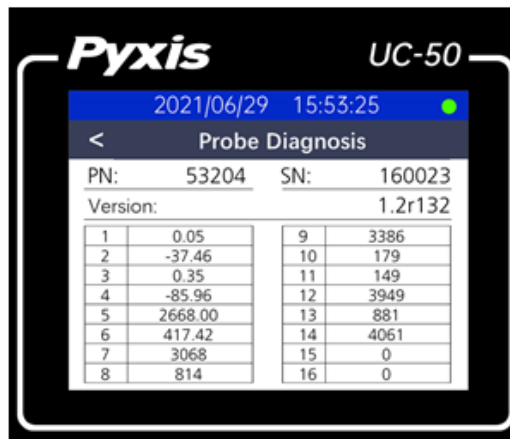

USB FUNCTION FOR HISTORICAL DATA UPLOAD AND FREQUENCY

UC-50 has a built-in USB interface to support historical data export and firmware upgrade function. Before accessing USB functions, please make sure USB thumb drive is properly plugged into UC-50 USB interface. **For data download and upload to the UC-50 a USB device with a storage capacity between 8 and 64MB *Megabytes* is recommended.**

Export UC-50 Historical Data

Select USB Settings from the Settings screen. In the USB settings screen, historical data can be downloaded to a USB thumb driver by selecting Data Export function. Make sure a USB thumb drive is plugged into UC-50 before exporting historical data.

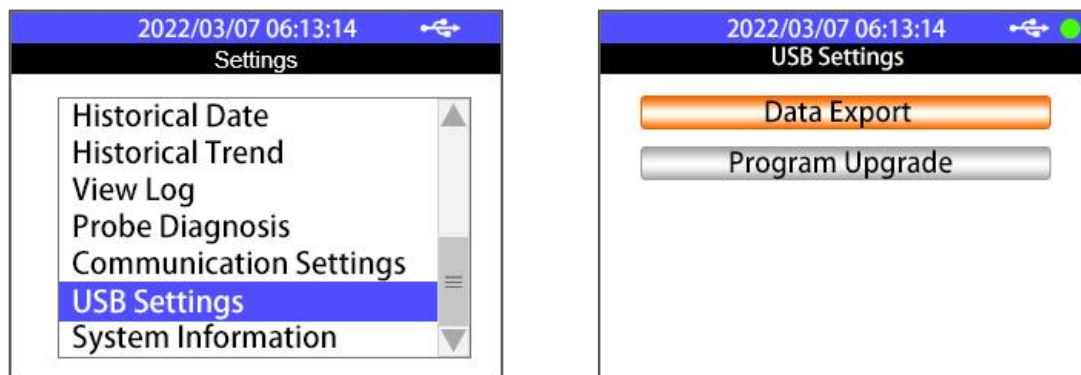

Further select the historical data date and time range or simply choose All Export to export all historical data. Once data export 100% completed, you can safely unplug the USB thumb drive. ***NOTE*** the date range for data upload should not exceed 12 months, otherwise, all data must be exported.

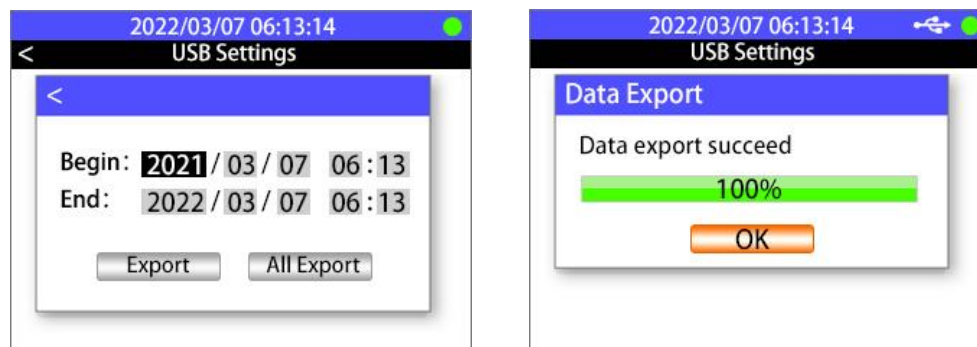

Adjust UC-50 Historical Data Interval

By default, UC-50 will save sensor value every 60 seconds to its internal data storage, if an application requires 3 months historical data export, UC-50 will generate over 10,000 lines of historical data if the historical data interval is set to 60 seconds. However, UC-50 allows customer to adjust historical data interval to

- 1) Reduce exported historical data file size if high resolution data is not required
- 2) Capture high resolution data if sensor value changes rapidly

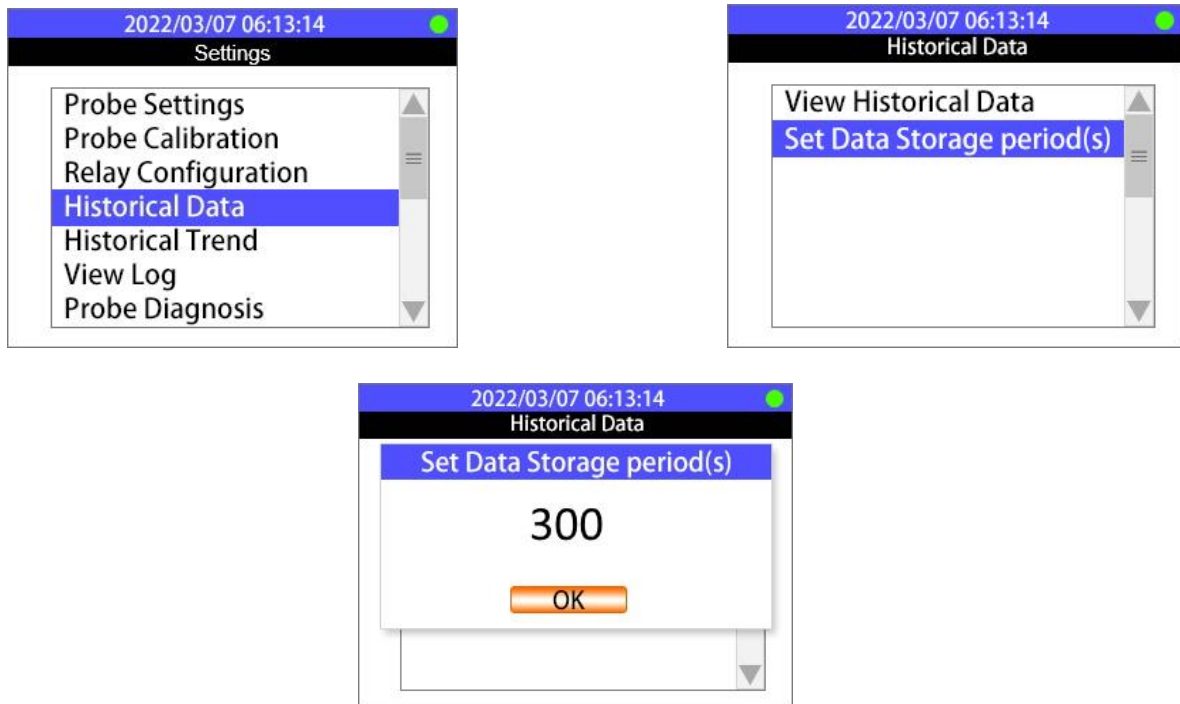

Upgrade UC-50 Firmware

Copy the target UC-50 firmware file (.bin) to the root directory of USB thumb drive, plug the thumb drive to UC-50 USB interface, select USB Settings in Settings page and select Program Upgrade function in USB Settings page. UC-50 will automatically start firmware upgrading procedure and reboot itself once the procedure completed.

Setting DATE & TIME in the UC-50 Display

1. Hit the **Main** Key
2. Hit the **Up** or **Down** Key until “System Information” is highlighted.
3. Hit the **OK** Key to enter the System Information Screen.
4. Hit the **Down** Key until the desired parameter is highlighted.

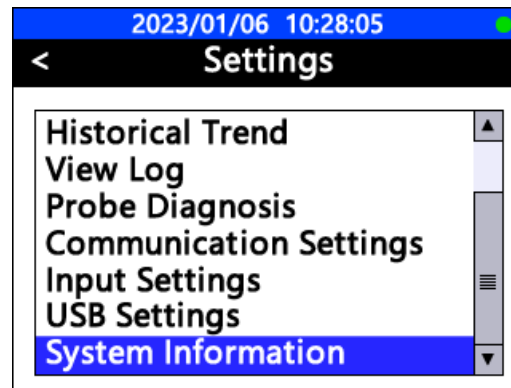

5. Hit the **OK** Key to select the desired parameter. The highlight should turn blue.
6. Push the **Up** or **Down** Key until the desired value is selected.
7. Hit the **OK** Key to confirm the new desired value.
8. Hit the **Main** Key to go back to the main screen.

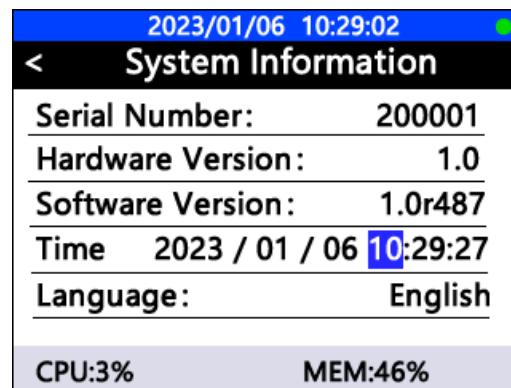

Explanation and use of the signal HOLD Feature

The signal **HOLD - ON/OFF** feature is a function used to set and maintain the sensor output signal data at a constant value during periods when the sensor is not stable and/or fluctuating significantly due to maintenance and calibration. Maintaining a user set output signal from the IK-765 Series panel allows the sensor to be removed and/or maintained while preventing out of compliance network alarms possibly interrupting process operation. When activated, the HOLD feature allows the user to set and retain the output signal for both sensor parameters for a period of 15 minutes, after which the unit returns to normal operation and live reading output value.

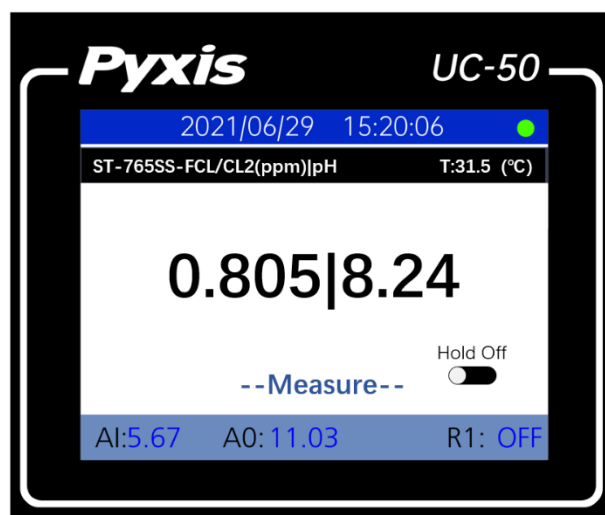

Long press **OK** button for 3 seconds on the main interface to open the **HOLD - ON/OFF** page. The cursor shows **black** is the selection mode, and **blue** is the editing mode. Click the **OK** key to enter the editing mode, and the **up/down** keys can be used to adjust the value of the setting item. Once set where desired, click the **OK** button to start the **HOLD-ON** function.

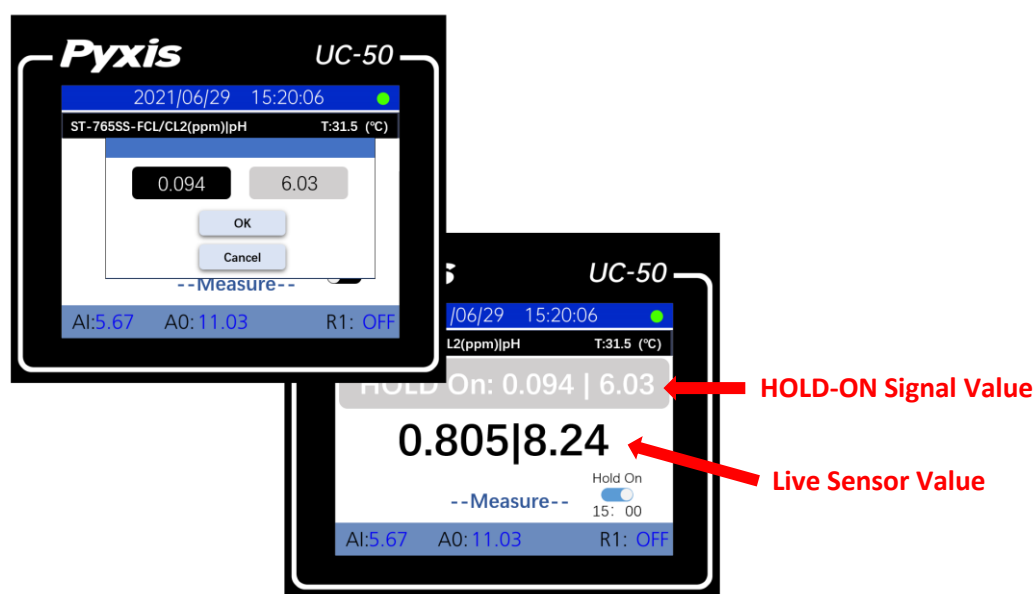

SENSOR CLEANING & MAINTENANCE

Most cleaning of the ST-765SS is facilitated by removing the sensor, rinsing it with tap or DI water and gently wiping the sensor head with a soft cloth or Q-tips, then re-rinse. For a highly fouled sensor, soak the lower half of the sensor in 100 mL Pyxis inline sensor cleaning solution for 10-15 minutes. Gently rub the sensor electrode head with the provided Q-tips. If the surface is not entirely clean, continue to soak the sensor for an additional time until clean. Rinse the sensor with distilled water. Pyxis Lab Inline Sensor Cleaning Solution can be purchased at our online Estore/Catalog at <https://pyxis-lab.com/product/probe-cleaning-kit/>



ST-Series Probe Cleaning Kit (P/N SER-01)

COMMON SENSOR TROUBLESHOOTING

If the ST-765SS sensor output signal is not stable and fluctuates significantly, make an additional solution ground connection—connect the black ground wire to a conductor that contacts the sample water electrically such as a brass pipe adjacent to the ST-765SS.

REPLACING pH / OXIDIZER ELECTRODE HEAD

The pH/oxidizer electrode head of ST-765SS Series can be replaced when the original electrode head reaches its working life.

Order a replacement electrode head EH-765 (P/N 53061) from Pyxis and follow instructions as below.

1. Turn off the sensor if it is powered on.
2. Make sure there is no water on the sensor.
3. Hold the ST-765SS main body with one hand and use the other hand to twist the stainless-steel locking ring counter-clockwise until the front end of the black electrode is completely unscrewed, as shown in *Figure 2*.
4. Pull out the electrode head as shown in *Figure 3*.
5. Loosen the electrode plug connector, and remove the electrode head, as show in *Figure 4*.
6. To assemble the new electrode head, connect the plug, then insert the new electrode head into the main sensor housing and ensure that the two protrusions on the electrode head are aligned with the notches in the sensor main housing.
7. Then twist the stainless-steel lock ring of ST-765SS in a clockwise direction until the threads of the electrode head completely enter the ST-765SS housing as shown in *Figure 1*.

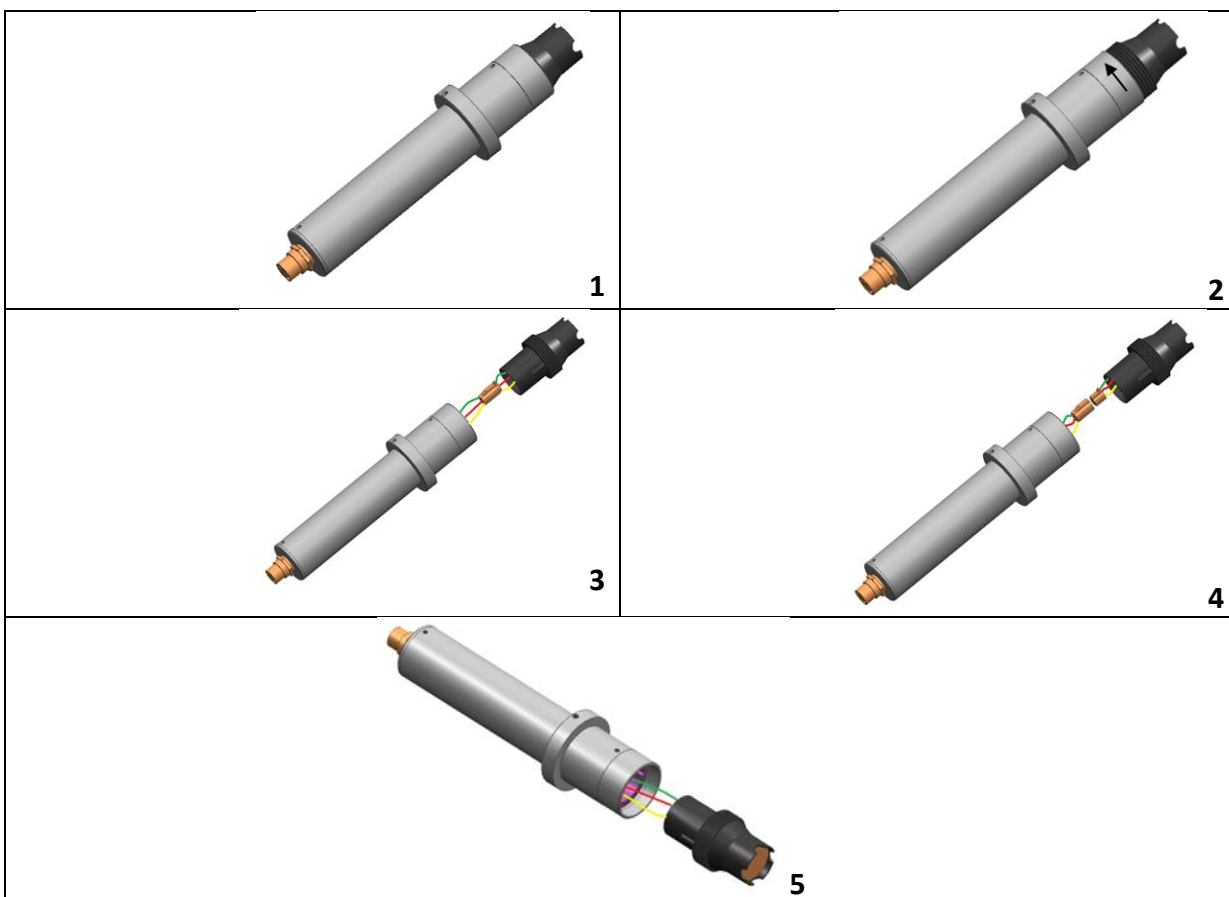

Replacing EH-765 pH and Oxidizer Electrode Head

Order InformationIK-765SS-FCL (*Free Chlorine + pH + Temperature Analyzer*)**P/N**

42082

IK-765SS-CLO (*Chlorine Dioxide + pH + Temperature Analyzer*)

42085

Optional / Replacement Accessories Information**P/N**ST-765SS-FCL (*Free Chlorine + pH + Temperature Sensor w/Internal Compensation-Sensor Only*)

53607-NFR

ST-765SS-CLO (*Chlorine Dioxide + pH + Temperature Sensor w/Internal Compensation-Sensor Only*)

53608-NFR

EH-765 (*Replacement Electrode Head for ST-765SS-Series Sensors*)

53061

FR-50 (*Replacement FR-50 Flow Reservoir w/Rotameter & PRV*)

50700-A01

UC-50 Display + Data Logging Terminal (*Replacement*)

43007

SP-200 OxiPocket™ (*Pocket All-Oxidizing Disinfectants Colorimeter & Fluorometer*)

50802

Pyxis pH Calibration Combo Pack (*4-7-10 Calibration Solution 3-Pack-500mL each*)

57007

Zero Oxidizer Calibration Standard Solution (*500mL Bottle*)

20022

ST-SERIES PROBE CLEANING KIT

SER-01